

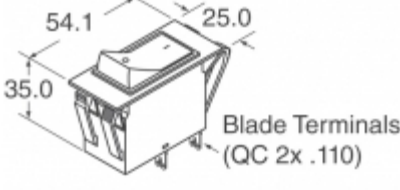

3120-F321-P7M1-W19DG2-16A



Blade Terminals (QC 2x .110)

Images are for reference only.
See Product Specifications for product details.
Buy 3120-F321-P7M1-W19DG2-16A with confidence from Component-World.HK, 1 Year Warranty



Part Number: [3120-F321-P7M1-W19DG2-16A](#)
Manufacturer: [E-T-A](#)
Description: CIR BRKR THRM 16A 250VAC 50VDC
Data sheet:  [3120-F Series Datasheet](#)











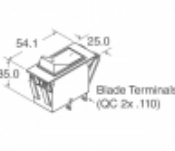
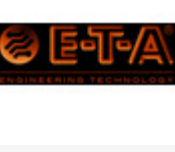





RoHS Status: Lead free / RoHS Compliant
Ship From: Hong Kong
Shipment Way: DHL/Fedex/TNT/UPS/EMS

[Request For Quotation](#)

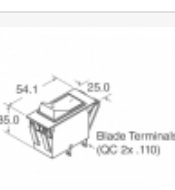
PRODUCT PARAMETER			
Part Number	3120-F321-P7M1-W19DG2-16A	Manufacturer	E-T-A
Description	CIR BRKR THRM 16A 250VAC 50VDC	Lead Free Status / RoHS Status	Lead free / RoHS Compliant
Quantity Available	1598 pcs	Data sheet	3120-F Series Datasheet
Category	Circuit Protection	Voltage Rating - DC	50V
Voltage Rating - AC	250V	Series	3120-F
Number of Poles	2	Mounting Type	Panel Mount
Moisture Sensitivity Level (MSL)	1 (Unlimited)	Manufacturer Standard Lead Time	9 Weeks
Lead Free Status / RoHS Status	Lead free / RoHS Compliant	Illumination Voltage (Nominal)	20V
Illumination	Green	Current Rating	16A
Breaker Type	Thermal	Actuator Type	Rocker

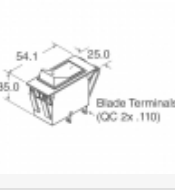
Component-World.com is a Reliable Stocking Distributor of Electronic Components. We specialize in all E-T-A series electronic components. We have 1598 pieces of E-T-A 3120-F321-P7M1-W19DG2-16A in stock available now. Request a quote from electronics components distributor at Component-World.com, our sales team will contact you within 24 hours.

RFQ Email: info@Components-World.com

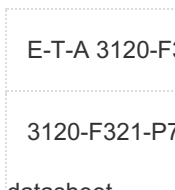
RELATED PRODUCTS			
	Part#: 3120-F321-H7T1-W19DG4-20A Description: CIR BRKR THRM 20A 250VAC 50VDC	Manufacturers: E-T-A	RFQ
	Part#: 3120-F321-H7T1-W19DG4-5A Description: CIRC BRKR THRM	Manufacturers: E-T-A	RFQ
	Part#: 3120-F321-P7T1-W01D-14A Description: CIR BRKR THRM 14A 250VAC 50VDC	Manufacturers: E-T-A	RFQ
	Part#: 3120-F321-P7T1-W01D-10A Description: CIR BRKR THRM 10A 250VAC 50VDC	Manufacturers: E-T-A	RFQ
	Part#: 3120-F321-P7T1-W01D-15A Description: CIR BRKR THRM 15A 250VAC 50VDC	Manufacturers: E-T-A	RFQ
	Part#: 3120-F321-P7T1-W01D-15A-T Description: CIR BRKR THRM 15A 250VAC 50VDC	Manufacturers: E-T-A	RFQ
	Part#: 3120-F321-P7T1-W01D-1.2A Description: CIRC BRKR THRM	Manufacturers: E-T-A	RFQ
	Part#: 3120-F321-P7T1-W01D-12A Description: CIR BRKR THRM 12A 250VAC 50VDC	Manufacturers: E-T-A	RFQ
	Part#: 3120-F321-P7T1-M01G-2.5A Description: CIR BRKR THRM 2.5A 250VAC 50VDC	Manufacturers: E-T-A	RFQ
	Part#: 3120-F321-P7T1-W01A-16A Description: CIR BRKR THRM 16A 250VAC 50VDC	Manufacturers: E-T-A	RFQ
	Part#: 3120-F321-H7T1-W19DG4-8A Description: CIR BRKR THRM 8A 250VAC 50VDC	Manufacturers: E-T-A	RFQ
	Part#: 3120-F321-H7T1-W19LG3-15A Description: CIR BRKR THRM 15A 250VAC 50VDC	Manufacturers: E-T-A	RFQ
	Part#: 3120-F321-P7T1-W01D-0.5A Description: CIR BRKR THRM 500MA 250VAC 50VDC	Manufacturers: E-T-A	RFQ
	Part#: 3120-F321-H7T1-W19LG3-X3120-U0001M-20A Description: CIR BRKR THRM 20A 250VAC 50VDC	Manufacturers: E-T-A	RFQ
	Part#: 3120-F321-P7M1-W01A-2.5A Description: CIRC BRKR THRM	Manufacturers: E-T-A	RFQ
	Part#: 3120-F321-P7M1-W01X-15A Description: CIR BRKR THRM 15A 250VAC 50VDC	Manufacturers: E-T-A	RFQ
	Part#: 3120-F321-P7T1-W01D-0.3A Description: CIR BRKR THRM 300MA 250VAC 50VDC	Manufacturers: E-T-A	RFQ
	Part#: 3120-F321-H7T1-W19DG4-15A Description: CIR BRKR THRM 15A	Manufacturers: E-T-A	RFQ
	Part#: 3120-F321-H7T1-W19LB3-10A Description: CIR BRKR THRM 10A 250VAC 50VDC	Manufacturers: E-T-A	RFQ
	Part#: 3120-F321-H7T1-W19LG3-X3120-U0001M-10A Description: CIR BRKR THRM 10A	Manufacturers: E-T-A	RFQ

Related keywords for **3120-F321-P7M1-W19DG2-16A**

E-T-A 3120-F321-P7M1-W19DG2-16A	3120-F321-P7M1-W19DG2-16A distributor	3120-F321-P7M1-W19DG2-16A supplier	3120-F321-P7M1-W19DG2-16A price
3120-F321-P7M1-W19DG2-16A download	3120-F321-P7M1-W19DG2-16A datasheet	3120-F321-P7M1-W19DG2-16A stock	buy 3120-F321-P7M1-W19DG2-16A
datasheet	E-T-A 3120-F321-P7M1-W19DG2-16A		